



NAME OF PRODUCT	Super SQV IV Kit
PART NUMBER	7 1 0 0 8 - K T 0 0 1
APPLICATION	TOYOTA Supra MA70
ENGINE	7M-GTE
YEAR	1987 ~ 1992

E04531-T40040-00 2011/3/25 Ver.3-1.01

Published in March, 2011 by HKS Co., Ltd.  
(Unauthorized reproduction is strictly prohibited.)

## NOTICE

This manual assumes that you have and know how to use the tools and equipment necessary to safely perform service operations on your vehicle. This manual assumes that you are familiar with typical automotive systems and basic service and repair procedures. Do not attempt to carry out the operations shown in this manual unless these assumptions are correct. Always have access to a factory repair manual. To avoid injury, follow the safety precautions contained in the factory repair manual.

### SAFETY PRECAUTIONS

#### WARNING

- To prevent electrical damage/burns/fire, always:
  - Disconnect the negative terminal of the battery before beginning installation.
  - When disconnecting wires/connectors, take extra care to avoid breaking/snapping the connectors.

#### CAUTION

- Do not misuse this product.
  - Misuse of this product may lead to engine damage.
  - Misuse of this product may lead to loss of its original function.
- Prior to installation, make sure the engine bay temperature has cooled to approximately 40°C /104°F.
  - Failure to let the engine cool down properly can lead to severe burns.
- Insert clean rags into open piping to prevent contaminants from entering the pipes.
  - If neglected, contaminants in the piping can lead to engine damage.

- Make sure that all of the parts listed in the Parts List are included in the kit.
- Reference the factory service manual for the vehicle when removing factory parts.
- Be careful when handling this product; avoid dropping or subjecting it to excessive impact. Failure to do so may result in product damage or improper installation.
- Use the proper tools when tightening nuts and bolts. If over tightened, the bolts may become damaged.
- Keep the removed factory parts in a safe place for ease of re-installation at a later date (if necessary).  
When reinstalling the removed factory parts, make sure to reinstall them correctly.

## INSTALLATION PROCEDURE

### 1. REMOVAL OF FACTORY PARTS

Remove the parts in accordance with the factory service manual.

- (1) Remove the cable from the negative terminal of the battery.
- (2) Remove the air bypass valve, air inlet hose, and air inlet pipe. (Dia.1)

#### ADVICE:

During removal and installation, make sure no foreign objects get inside the pipes and hoses.

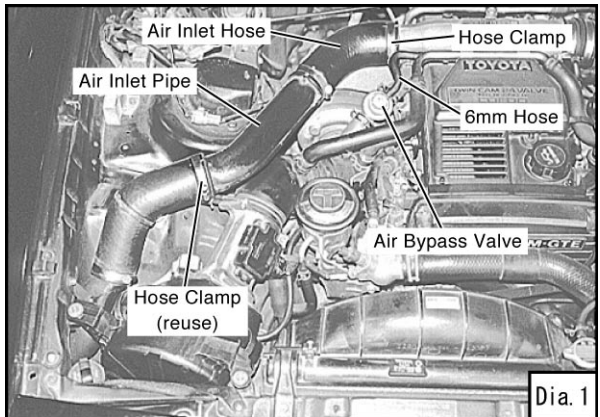

### 2. INSTALLING THE KIT

- (1) Install the 20mm rubber cap onto the chamber pipe and suction pipe by using parts included in this kit. (Dia.2)

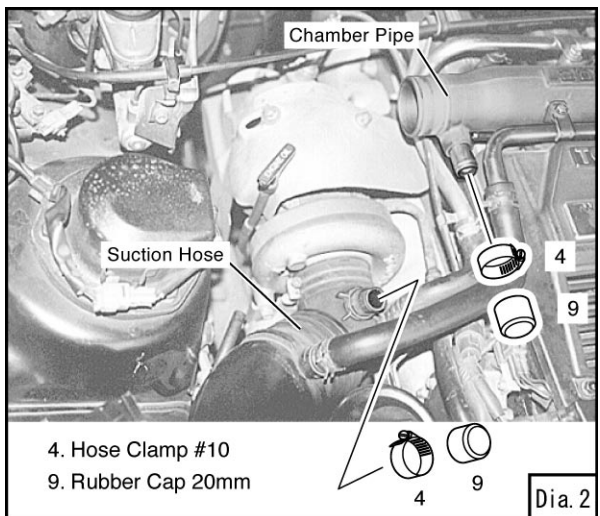

- (2) Install the kit parts. (Dia.3)

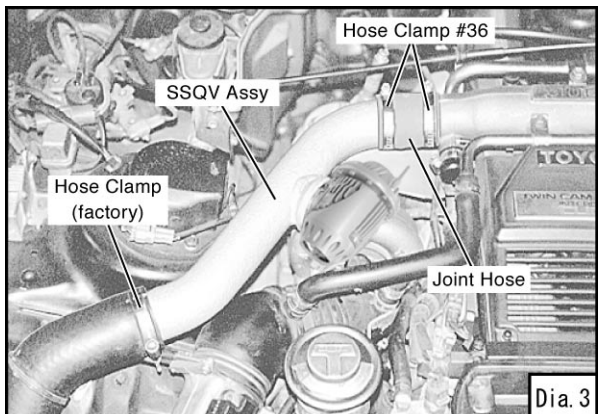

- Install the vacuum hose using the provided air filter and attach the other end to the SSQV. Cut the 4mm hose to the appropriate length. (Make sure to leave some slack.) (Dia.4)

**The SSQV must be activated by intake manifold pressure.**

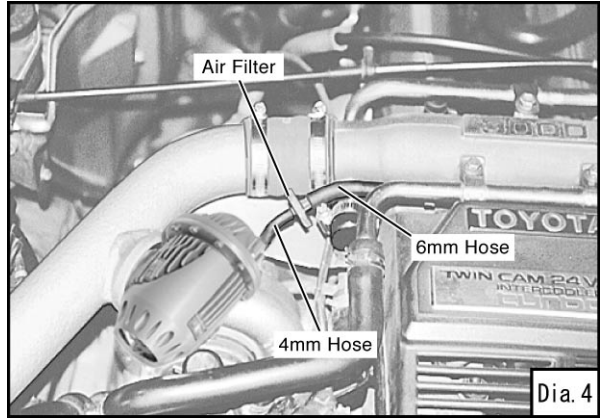

- Secure the 4mm Hose connected to the SSQV Assy Fitting using a Tie Wrap. (Dia.4, 5)

**ADVICE:**

When uninstalling the SSQV Assy or when removing the 4mm Hose from the SSQV Assy, remove the Tie Wrap, cut the hose past the port on the SSQV Assy, slice the 4mm Hose lengthwise and then remove the 4mm Hose. (Dia.5)

Do not pull or wriggle the 4mm Hose using pliers or other tools to prevent damage to the SSQV Assy.

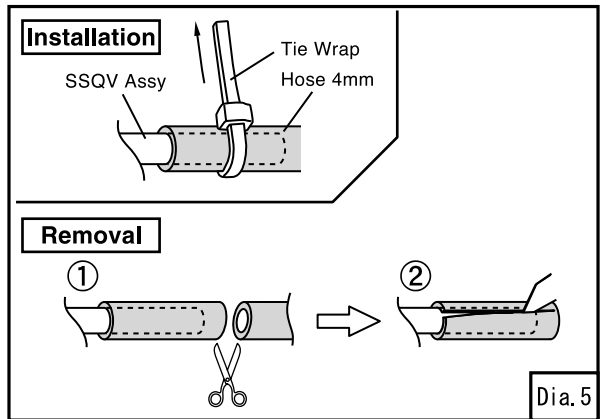

- Reconnect the battery cable on the negative terminal of the battery.

## How to install the Super SQV Recirculation Fitting

If it is necessary to recirculate the SSQV back into the suction pipe, please refer to the instructions below. Miscellaneous hose clamps, suction pipe fitting, and return hose are not included in this kit.

- Remove 4 bolts (per diagram) and remove the cover.

**NOTE**

Do not remove the remaining 4 bolts as they are to stay affixed to the SSQV main body.

- After removal of the cover, the recirculation fitting can be removed.
- Install the Recirculation Fitting. Reinstall the cover and retighten the 4 bolts.

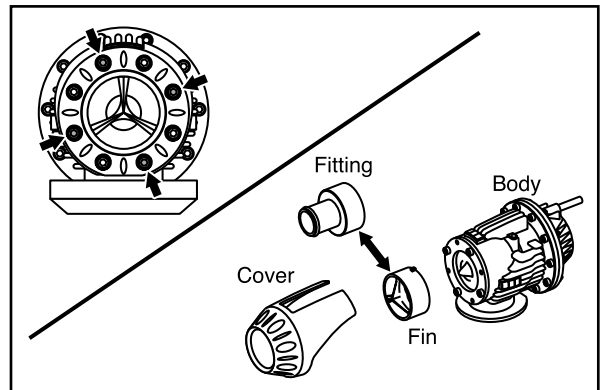

## CONFIRMATION AFTER INSTALLATION

Check the following after the installation process is complete.











(1) Check the following before starting the engine:

- Make sure all pipes and hoses are routed and connected correctly.
- Make sure all hose clamps are tightened.
- Make sure the negative cable terminal is securely attached to the battery.
- Make sure all bolts and nuts are tightened.
- Make sure all installed components do not come in contact with other parts.

(2) Start the engine and check the following:

- Make sure air is not leaking.
- Make sure the RPM rises smoothly after revving the engine 2-3 times while in neutral.
- Make sure the installed parts are not hitting each other.
- Make sure there are no unusual conditions found while idling.
- Make sure there are no loose bolts after turning off the engine. Re-tighten if necessary.

## PARTS LIST

No.	Description	QT	Image	Remarks	No.	Description	QT	Image	Remarks	No.	Description	QT	Image	Remarks
1	SSQV Assy	1			5	Hose	1		6mm L=50	9	Tie Wrap	5		
2	Joint Hose	1		55mm L=70	6	Hose	1		4mm L=300	10	Recirculation Fitting	1		
3	Hose Clamp	2		# 36	7	Air Filter	1			11	Instruction Manual	1		
4	Hose Clamp	2		# 10	8	Rubber Cap	2		20mm	12				

## MAINTENANCE

Proper maintenance of this product is necessary in order to maintain the safety, reliability, and function of this product.

- Maintenance is the responsibility of the driver/owner.
- If work needs to be performed outside the scope of this manual, consult a professional.
- If the vehicle gets damaged, have the repairs performed by a professional.
- If you experience any abnormal noise, smell, or vibration from the vehicle while driving, reference the vehicle's Owner's Manual.
- If this product is ever re-sold, please give this Instruction Manual to the new owner.
- When removing this product from the vehicle, please consult a professional.



株式会社 エッチ・ケー・エス

〒418-0192 静岡県富士宮市北山7181

<http://www.hks-power.co.jp/>

( 禁無断複写、転載 )